

ADR-GGVS Steckverbinder + ABS Leitungen

	Seite
„SEAL-fähige“ Steckverbinder	
4-polig – gerade / winkelig	16
4-polig – Stecker ohne Schutzkappe	17
5-polig – gerade	18
5-polig – winkelig	19
8-polig – Stecker	20
8-polig – Steckdose für Flanschmontage	21
8-polig – Steckdose für Wellenschlauchanschluss	22
35-polig – Stecker/Steckdose	23 - 24
37-polig – Stecker	25
Kontakte/SEALS/Werkzeuge für SEAL-Steckverbinder	26 - 27
„Nicht SEAL-fähige“ Steckverbinder	
3-polig	28
5-polig	29
8-polig – für Flanschmontage	30
8-polig – für Wellenschlauchanschluss	31
16-polig – Stecker/Steckdose	32 - 33
21-polig – Stecker/Steckdose	34 - 35
37-polig – Stecker/Steckdose	36 - 37
Stift-/Buchsenkontakte	38
Werkzeuge	39
Sondersteckverbinder	
3-polig	40
3-polig – Montagepackungen	41
2-/3-polig – mit Gewinde M 24 x 1	42
2-/3-/4-polig – mit Gewinde M 27 x 1	43
2-/3-/4-polig – mit Bajonett	44
Dichtungen für Sondersteckverbinder	45
ABS/EBS-Steckverbinder & Leitungen	
ABS/EBS/15-pol. Steckverbinder	46
ABS-Parkdose	47
Ersatzkontakte	47
ABS/EBS/15-pol. Wendelleitungen	48

ADR-GGVS Connectors + ABS Conduits

	page
„Suitable for SEAL“ Connectors	
4-pole – straight / angle	16
4-pole – Plug without protection cap	17
5-pole – straight	18
5-pole – angle	19
8-pole – Plug	20
8-pole – Socket for flange assembly	21
8-pole – Socket for corrugated tube	22
35-pole – Plug/Socket	23 - 24
37-pole – Plug	25
Contacts/SEALS/Tools for SEAL Connectors	26 - 27
„Not suitable for SEAL“ Connectors	
3-pole	28
5-pole	29
8-pole – for flange assembly	30
8-pole – for corrugated tube assembly	31
16-pole – Plug/Socket	32 - 33
21-pole – Plug/Socket	34 - 35
37-pole – Plug/Socket	36 - 37
Pin-/Jack contacts	38
Tools	39
Special Connectors	
3-pole	40
3-pole – Assembly packages	41
2-/3-pole – with thread M 24 x 1	42
2-/3-/4-pole – with thread M 27 x 1	43
2-/3-/4-pole – with bayonet	44
Sealings for Special Connectors	45
ABS/EBS-Connectors & Conduits	
ABS/EBS/15-pole connectors	46
ABS-Parking socket	47
Replacement contacts	47
ABS/EBS/15-pole conduits	48

4-poliger Stecker SEAL



Material:
Polybutyleneterephthalat
Polyamid
Silikon

Temperaturbereich:
-40°C bis 125°C

Brennbarkeit:
UL 94: HB

Farbe(n)/Ausführungen:
• Farben: s. Tabelle
• ohne/mit Druckausgleich

4-pole Plug SEAL

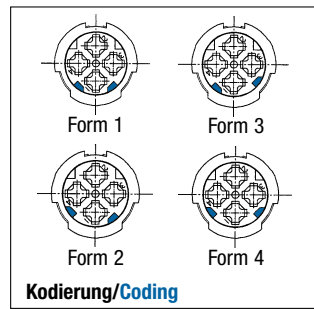

Material:
Polybutyleneterephthalate
Polyamide
Silicone

Temperature range:
-40°C to 125°C

Flammability:
UL 94: HB

Colour(s)/Designs:
• Colours: s. table
• without/with pressure compensation

Characteristics:
• Acc. to ISO15170 (former DIN 72585)
• Contact system: Ø 2,5 mm

Accessories (see chapter...):
• Contacts (5.2)
• Seals (5.2)
• Tools (5.2)
• Secondary lock (5.3) optional

Applications:
• Heavy trucks
• Agricultural machines
• Construction machines
• Suitable for corrugated tubes NW 8,5 and NW 4,5

Eigenschaften:
• Nach ISO 15170 (ehemals DIN 72585)
• Kontaktsystem: Ø 2,5 mm

Zubehör (siehe Kapitel...):
• Kontakte (5.2)
• Seals (5.2)
• Werkzeuge (5.2)
• Sekundärverriegelung (5.3) optional

Anwendungsbereiche:
• NFZ
• Landmaschinen
• Baumaschinen
• Geeignet für Welschläuche NW 8,5 und NW 4,5

5.2

Kodierung Form	Ausführung Design	Farbe Buchsengehäuse Colour Jack housing	Farbe Bajonettmutter Colour Bayonet nut	Art.-Nr. Art. no.	VE Stck. PU pcs.
----------------	-------------------	--	---	-------------------	------------------

gerade/straight

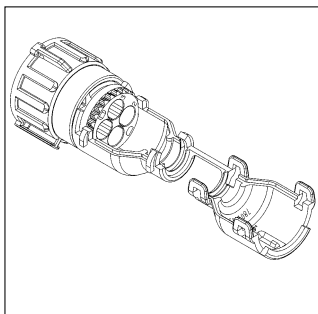

für Welschlauch NW 8,5/for corrugated tube NW 8,5					
1	ohne Druckausgleich/without pressure compensation mit Druckausgleich/with pressure compensation	schwarz / black schwarz/black	schwarz / black grau / grey	9800350 9800340	100 100
2	ohne Druckausgleich/without pressure compensation mit Druckausgleich/with pressure compensation	grau / grey grau / grey	schwarz / black grau / grey	9800351 9800341	100 100
3	ohne Druckausgleich/without pressure compensation mit Druckausgleich/with pressure compensation	grün / green grün / green	schwarz / black grau / grey	9800352 9800342	100 100
4	ohne Druckausgleich/without pressure compensation mit Druckausgleich/with pressure compensation	blau / blue blau / blue	schwarz / black grau / grey	9800353 9800343	100 100

Winkel/angle

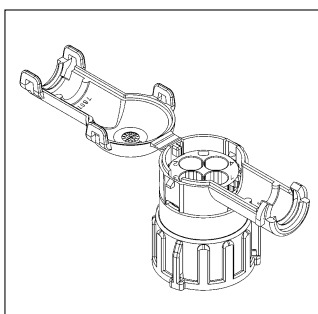

für Welschlauch NW 4,5/for corrugated tube NW 4,5					
1	ohne Druckausgleich/without pressure compensation mit Druckausgleich/with pressure compensation	schwarz / black schwarz / black	schwarz / black grau / grey	9800374 9800384	100 100
2	ohne Druckausgleich/without pressure compensation mit Druckausgleich/with pressure compensation	grau / grey grau / grey	schwarz / black grau / grey	9800375 9800385	100 100
3	ohne Druckausgleich/without pressure compensation mit Druckausgleich/with pressure compensation	grün / green grün / green	schwarz / black grau / grey	9800376 9800386	100 100
4	ohne Druckausgleich/without pressure compensation mit Druckausgleich/with pressure compensation	blau / blue blau / blue	schwarz / black grau / grey	9800377 9800387	100 100

für Welschlauch NW 8,5/for corrugated tube NW 8,5					
1	ohne Druckausgleich/without pressure compensation mit Druckausgleich/with pressure compensation	schwarz / black schwarz / black	schwarz / black grau / grey	9800330 9800320	100 100
2	ohne Druckausgleich/without pressure compensation mit Druckausgleich/with pressure compensation	grau / grey grau / grey	schwarz / black grau / grey	9800331 9800321	100 100
3	ohne Druckausgleich/without pressure compensation mit Druckausgleich/with pressure compensation	grün / green grün / green	schwarz / black grau / grey	9800332 9800322	100 100
4	ohne Druckausgleich/without pressure compensation mit Druckausgleich/with pressure compensation	blau / blue blau / blue	schwarz / black grau / grey	9800333 9800323	100 100

4-poliger Stecker

SEAL ohne Schutzkappe



- Material:**
Polybutyleneterephthalat
Polyamid
Silikon
- Temperaturbereich:**
-40°C bis 125°C
- Brennbarkeit:**
UL 94: HB
- Farbe(n)/Ausführungen:**
- Farben: s. Tabelle
 - ohne/mit Druckausgleich

4-pole Plug

SEAL without protection cap

- Eigenschaften:**
- Nach ISO 15170 (ehemals DIN 72585)
 - Kontaktsystem: Ø 2,5 mm
- Zubehör (siehe Kapitel...):**
- Kontakte (5.2)
 - Seals (5.2)
 - Werkzeuge (5.2)
 - Sekundärverriegelung (5.3) optional
- Anwendungsbereiche:**
- NFZ
 - Landmaschinen
 - Baumaschinen

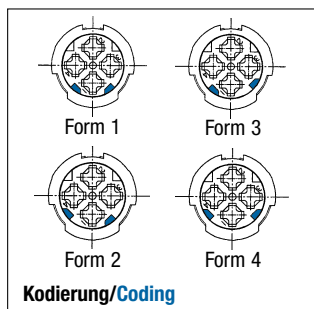

- Material:**
Polybutyleneterephthalate
Polyamide
Silicone
- Temperature range:**
-40°C to 125°C
- Flammability:**
UL 94: HB
- Colour(s)/Designs:**
- Colours: s. table
 - no/with pressure compensation

- Characteristics:**
- Acc. to ISO 15170 (former DIN 72585)
 - Contact system: Ø 2,5 mm
- Accessories (see chapter...):**
- Contacts (5.2)
 - Seals (5.2)
 - Tools (5.2)
 - Secondary lock (5.3) optional
- Applications:**
- Heavy trucks
 - Agricultural machines
 - Construction machines

Stecker/Plug

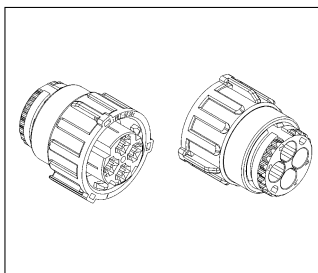

Kodierung Form	Ausführung Design	Farbe Buchsengehäuse Colour Jack housing	Farbe Bajonettmutter Colour Bayonet nut	Art.-Nr. Art. no.	VE Stck. PU pcs.
1	ohne Druckausgleich/without pressure compensation mit Druckausgleich/with pressure compensation	schwarz/black schwarz/black	schwarz/black grau/grey	9800310 9800300	100 100
2	ohne Druckausgleich/without pressure compensation mit Druckausgleich/with pressure compensation	grau/grey grau/grey	schwarz/black grau/grey	9800311 9800301	100 100
3	ohne Druckausgleich/without pressure compensation mit Druckausgleich/with pressure compensation	grün/green grün/green	schwarz/black grau/grey	9800312 9800302	100 100
4	ohne Druckausgleich/without pressure compensation mit Druckausgleich/with pressure compensation	blau/blue blau/blue	schwarz/black grau/grey	9800313 9800303	100 100

5-poliger Steckverbinder

SEAL
Gerade



IP 67

Material:
Polyamid 6/66
Perbunan

Temperaturbereich:
-40°C bis 105°C
Bei Verwendung mit Zubehör bitte die jeweiligen Zubehör-Temperaturangaben beachten.

Farbe(n)/Ausführungen:

- schwarz/grau
- Montagepackungen ab 100 Stück auf Anfrage

5-pole Connector

SEAL
Straight

Eigenschaften:

- Kontaktsystem: Ø 1,6 mm

Zubehör (siehe Kapitel...):

- Kontakte (5.2)
- Seals (5.2)
- Werkzeuge (5.2)
- Sekundärverriegelung (5.3) optional

Anwendungsbereiche:

- NFZ
- Landmaschinen
- Baumaschinen



Material:
Polyamide 6/66
Perbunan

Temperature range:
-40°C to 105°C
When used with accessories please mind the respective accessory temperature data.

Colour(s)/Designs:

- black/grey
- Assembly packages from 100 pcs on request

Characteristics:

- Contact system: Ø 1,6 mm



Accessories (see chapter...):

- Contacts (5.2)
- Seals (5.2)
- Tools (5.2)
- Secondary lock (5.3) optional

Applications:

- Heavy trucks
- Agricultural machines
- Construction machines

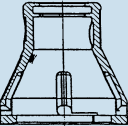
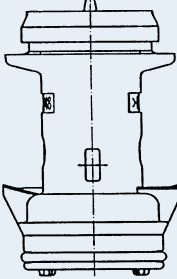
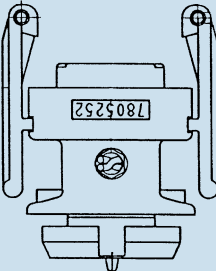
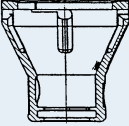
5.2

Bezeichnung Description	für for	Farbe Colour	Material Material	Art.-Nr. Art. no.	VE Stck. PU pcs.
 Wellenschlauch Corrugated tube	NW 8,5 NW 10				
 Gerade Schutzkappe Straight protection cap	NW 8,5 NW 10	schwarz black	Polyamid 66 Polyamide 66	7807665 7807263	50 50
 5-pol. Stiftgehäuse 5-pole pin housing	für Kontakt for contact Ø 1,6 mm	schwarz black	Polyamid 6 Perbunan Polyamide 6 Perbunan	7806248	50
		grau grey	Polyamid 6 Perbunan Polyamide 6 Perbunan	7806249	50
 5-pol. Buchsengehäuse 5-pole jack housing	für Kontakt for contact Ø 1,6 mm	schwarz black	Polyamid 6 Polyamide 6	7805252	50
		grau grey	Polyamid 6 Polyamide 6	7805253	50
 Gerade Schutzkappe Straight protection cap	NW 8,5 NW 10	schwarz black	Polyamid 66 Polyamide 66	7807665 7807263	50 50
 Wellenschlauch Corrugated tube	NW 8,5 NW 10				

5-poliger Stecker

SEAL Winkel

5-pole Connector

SEAL Angle



Material:
Polyamid 6
Perbunan

Temperaturbereich:
-40°C bis 105°C
Bei Verwendung mit Zubehör bitte die jeweiligen Zubehör-Temperaturangaben beachten.

Farbe(n)/Ausführungen:
• schwarz
• Montagepackungen ab 100 Stück auf Anfrage

Eigenschaften:
• Kontaktsystem: Ø 1,6 mm

Zubehör (siehe Kapitel...):
• Kontakte (5.2)
• Seals (5.2)
• Werkzeuge (5.2)
• Sekundärverriegelung (5.3) optional

Anwendungsbereiche:
• NFZ
• Landmaschinen
• Baumaschinen



Stiftgehäuse
Pin housing



Buchsengehäuse
Jack housing

Material:
Polyamid 6
Perbunan
Temperature range:
-40°C to 105°C
When used with accessories please mind the respective accessory temperature data.

Colour(s)/Designs:
• black
• Assembly packages from 100 pcs on request

Characteristics:
• Contact system: Ø 1,6 mm

Accessories (see chapter...):
• Contacts (5.2)
• Seals (5.2)
• Tools (5.2)
• Secondary lock (5.3) optional

Applications:
• Heavy trucks
• Agricultural machines
• Construction machines

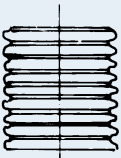
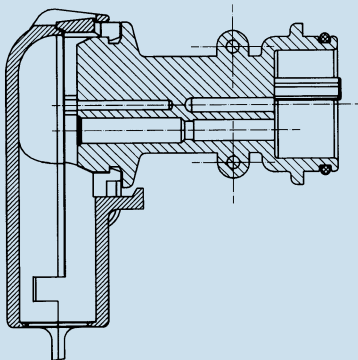
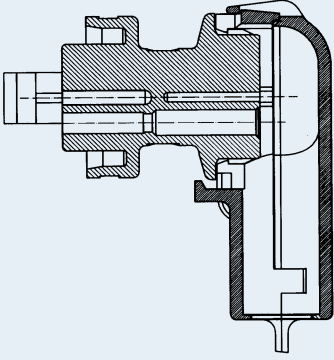
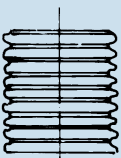
Bezeichnung Description	für for	Farbe Colour	Material Material	Art.-Nr. Art. no.	VE Stck. PU pcs.
 Wellschlauch Corrugated tube	NW 8,5 NW 10				
 5-pol. Stiftgehäuse mit Winkel-Schutzkappe 5-pole pin housing with angle protection cap	für Kontakt for contact Ø 1,6 mm	schwarz black	Polyamid 6 Perbunan Polyamide 6 Perbunan	7806252	50
	NW 8,5 NW 10			7806053	50
 5-pol. Buchsengehäuse mit Winkel-Schutzkappe 5-pole jack housing with angle protection cap	für Kontakt for contact Ø 1,6 mm	schwarz black	Polyamid 6 Polyamide 6	7805255	50
	NW 8,5 NW 10			7805056	50
 Wellschlauch Corrugated tube	NW 8,5 NW 10				

8-poliger Stecker SEAL

8-pole Plug SEAL



Material:
Polyamid 6
Silikon

Temperaturbereich:
-40°C bis 120°C

Bei Verwendung mit Zubehör bitte die jeweiligen Zubehör-Temperaturangaben beachten.

Farbe(n)/Ausführungen:

- schwarz
- Montagepackungen ab 100 Stück auf Anfrage

Eigenschaften:

- Kontaktbelegung:
7 x Buchsenkontakt Ø: 1,6 mm
1 x Buchsenkontakt Ø: 3,5 mm an Position '8'

Zubehör (siehe Kapitel...):

- Kontakte (5.2)
- Seals (5.2)
- Werkzeuge (5.2)
- Sekundärverriegelung (5.3) optional

Anwendungsbereiche:

- NFZ
- Landmaschinen
- Baumaschinen

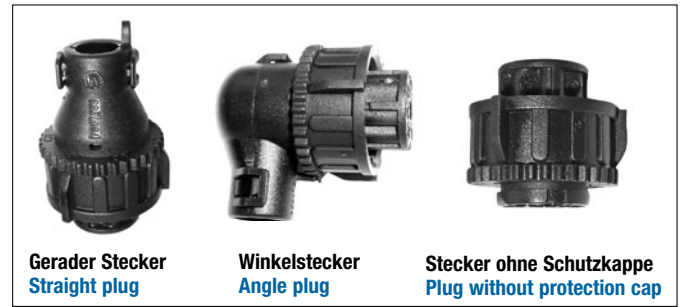

Gerader Stecker
Straight plug

Winkelstecker
Angle plug

Stecker ohne Schutzkappe
Plug without protection cap

Material:
Polyamid 6
Silicone

Temperature range:
-40°C to 120°C

When used with accessories please mind the respective accessory temperature data.

Colour(s)/Designs:

- black
- Assembly packages from 100 pcs on request

Characteristics:

- Contacts:
7 x jack contact Ø: 1,6 mm
1 x jack contact Ø: 3,5 mm on position '8'

Accessories (see chapter...):

- Contacts (5.2)
- Seals (5.2)
- Tools (5.2)
- Secondary lock (5.3) optional

Applications:

- Heavy trucks
- Agricultural machines
- Construction machines

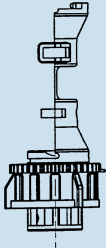
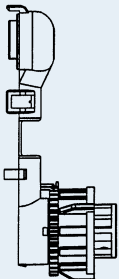
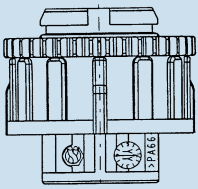
Bezeichnung Description	für for	Farbe Colour	Material Material	Art.-Nr. Art. no.	VE Stck. PU pcs.
 Wellschlauch Corrugated tube	NW 10				
 Gerader Stecker Straight plug		schwarz black	Polyamid 6 Silikon Polyamide 6 Silicone	9800681	50
 oder/or: Winkelstecker angle plug mit zusätzlicher Plombierbohrung with add. locking hole		schwarz black	Polyamid 6 Silikon Polyamide 6 Silicone Polyamid 6 Silikon Polyamide 6 Silicone	9800680 9800682	50 50
 oder/or: Stecker ohne Schutzkappe - kein Wellschlauch-Anschluss möglich, - keine Sekundärverriegelung einsetzbar Plug without protection cap - no corrugated tube assembly possible, - no secondary locking applicable		schwarz black	Polyamid 6 Silikon Polyamide 6 Silicone	9800617	50

8-polige Steckdose

SEAL für Flanschmontage



Material:
Polyamid 6
Silikon

Temperaturbereich:
-40°C bis 120°C
Bei Verwendung mit Zubehör bitte die jeweiligen Zubehör-Temperaturangaben beachten.

Farbe(n)/Ausführungen:

- Farben: s. Tabelle
- Montagepackungen ab 100 Stück auf Anfrage

8-pole Socket SEAL for Flange Assembly

Eigenschaften:

- für Flanschmontage
- Kontaktbelegung:
7 x Stiftkontakt Ø: 1,6 mm
1 x Stiftkontakt Ø: 3,5 mm an Position '8'

Zubehör (siehe Kapitel 5.2):

- Kontakte
- Seals
- Werkzeuge

Anwendungsbereiche:

- NFZ
- Landmaschinen
- Baumaschinen

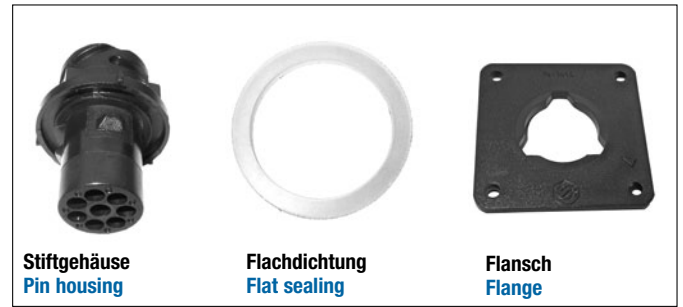

Stiftgehäuse
Pin housing

Flachdichtung
Flat sealing

Flansch
Flange

Material:
Polyamid 6
Silicone

Temperature range:
-40°C to 120°C
When used with accessories please mind the respective accessory temperature data.

Colour(s)/Designs:

- Colours: s. table
- Assembly packages from 100 pcs on request

Characteristics:

- for Flange assembly
- Contacts:
7 x pin Ø: 1,6 mm
1 x pin Ø: 3,5 mm on position '8'

Accessories (see chapter 5.2):

- Contacts
- Seals
- Tools

Applications:

- Heavy trucks
- Agricultural machines
- Construction machines

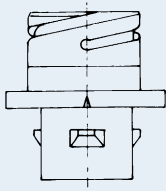
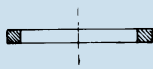
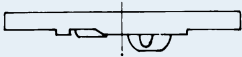
Bezeichnung Description	Farbe Colour	Material Material	Art.-Nr. Art. no.	VE Stck. PU pcs.
 <p>8-pol. Stiftgehäuse mit Bajonett 16 S 8-pole pin housing with bayonet 16 S</p>	schwarz black	Polyamid 6 Polyamide 6	7806390	50
 <p>Flachdichtung Flat sealing</p>	transparent transparent	Silikon Silicone	7813032	50
 <p>Flansch Flange</p>	schwarz black	Polyamid 6 Polyamide 6	7813015	50

5.2

8-polige Steckdose

SEAL für Well Schlauch-Anschluss

8-pole Socket

SEAL for corrugated tube assembly



Stiftgehäuse
Pin Housing



Material:
Polyamid 6
Neopren

Temperaturbereich:
-40°C bis 105°C
Bei Verwendung mit Zubehör bitte die jeweiligen Zubehör-Temperaturangaben beachten.

Farbe(n)/Ausführungen:
• Montagepackungen ab 100 Stück auf Anfrage

Eigenschaften:
• für Well Schlauch-Anschluss (optional Flansch möglich)

- Kontaktbelegung:
7 x Stiftkontakt Ø: 1,6 mm
1 x Stiftkontakt Ø: 3,5 mm an Position '8'

Zubehör (siehe Kapitel...):

- Kontakte (5.2)
- Seals (5.2)
- Werkzeuge (5.2)
- Klemmdichtring (5.3)

Anwendungsbereiche:

- NFZ
- Landmaschinen
- Baumaschinen

Material:
Polyamid 66
Neoprene

Temperature range:
-40°C to 105°C
When used with accessories please mind the respective accessory temperature data.

Colour(s)/Designs:
• Assembly packages from 100 pcs on request



Characteristics:
• for corrugated tube (optional flange possible)

- Contacts:
7 x jack contact Ø: 1,6 mm
1 x jack contact Ø: 3,5 mm on position '8'

Accessories (see chapter...):

- Contacts (5.2)
- Seals (5.2)
- Tools (5.2)
- Clamp sealing (5.3)

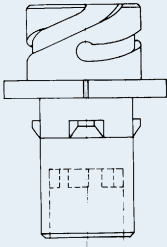
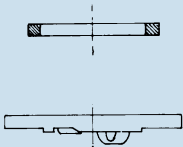
Applications:
• Heavy trucks
• Agricultural machines
• Construction machines

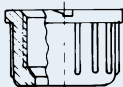
Bezeichnung Description	für for	Farbe Colour	Material Material	Art.-Nr. Art. no.	VE PU
 <p>Stiftgehäuse mit Bajonett 16 S Pin housing with bayonet 16 S</p> <p>mit zusätzlicher Plombierbohrung with add. locking hole</p>		schwarz black	Polyamid 6 Polyamide 6	9800575	50
		schwarz black	Polyamid 6 Polyamide 6	9800576	50
 <p>Flachdichtung mit Flansch (optional) Flat sealing with Fange (optional)</p>		transparent transparent	Silikon Silicone	7813032	50
		schwarz black	Polyamid 6 Polyamide 6	7813015	50
 <p>Klemmdichtring Clamp sealing</p>	NW 13	schwarz black	Neopren Neoprene	8117136	50
 <p>Well Schlauch Corrugated tube</p>	NW 13				
 <p>Überwurfmutter Cap nut</p>	NW 13	grau grey	Polyamid Polyamide	9800956	50

35-poliger Steckverbinder

SEAL
(Aufbau)



IP 67

Material:
Polyamid 66
30 % glasfaserverstärkt
Neopren
Polycarbonat
Silikon

Temperaturbereich:
-40°C bis 105°C
Bei Verwendung mit Zubehör bitte die jeweiligen Zubehör-Temperaturangaben beachten.

Farbe(n)/Ausführungen:
• schwarz/grau
• Montagepackungen ab 100 Stück auf Anfrage

35-pole Connector

SEAL
(Assembling)

Zubehör (siehe Kapitel...):

- Kontakte (5.2)
- Seals (5.2)
- Werkzeuge (5.2)
- Überwurfmutter (5.3)
- Klemmdichtring (5.3)
- Adapter (5.3)
- Zentrierscheibe (5.3)
- 90°-Winkel (5.3)
- Staubkappe (5.3)
- Sekundärverriegelung (5.3) optional

Anwendungsbereiche:

- NFZ
- Landmaschinen
- Baumaschinen



Stecker
Plug



Steckdose
Socket

Material:
Polyamide 66
30 % glassfibre reinforced
Neoprene
Polycarbonat
Silicone
Temperature range:
-40°C to 105°C
When used with accessories please mind the respective accessory temperature data.









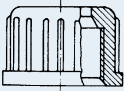

Colour(s)/Designs:
• black/grey
• Assembly packages from 100 pcs on request

Accessories (see chapter...):

- Contacts (5.2)
- Seals (5.2)
- Tools (5.2)
- Cap nut (5.3)
- Clamp sealing (5.3)
- Adaptor (5.3)
- Center plate (5.3)
- 90°-angle (5.3)
- Dust cap (5.3)
- Secondary lock (5.3) optional

Applications:
• Heavy trucks
• Agricultural machines
• Construction machines

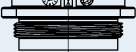
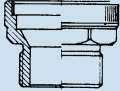
5.2

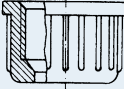
Bezeichnung Description	für for	Farbe Colour	Material Material	Art.-Nr. Art. no.	VE Stck. PU pcs.
 Überwurfmutter Cap nut	NW 17 NW 22 NW 29	grau grey	Polyamid Polyamide	9800697 9800905 9801138	50 50 50
 Wellenschlauch Corrugated tube	NW 17 NW 22 NW 29				
 Klemmdichtring Clamp sealing	NW 17 NW 22 NW 29	schwarz black	Neopren Neoprene	8117179 8117225 8117292	50 50 50
 Adapter Adaptor	NW 17 NW 22 NW 29	schwarz black	Polyamid 66 GF30 Polyamide 66 GF30	7807259 7807260 7807341	50 50 50
 Stecker-Stiftgehäuse Plug-pin housing		schwarz black	Polyamid 66 GF30 Silikon Polyamide 66 GF30 Silicone	7811222	50
 Stecker-Buchsengehäuse Plug-jack housing				7812226	50
 optional Zentrierscheibe optional Center plate	optional optional	transparent transparent	Polycarbonat Polycarbonate	7810403	50
 Steckdose-Buchsengehäuse Socket-jack housing		schwarz black	Polyamid 66 GF30 Polyamide 66 GF30	7812218	50
 Steckdose-Stiftgehäuse Socket-pin housing				7811230	50
 Adapter Adaptor	NW 17 NW 22 NW 29	schwarz black	Polyamid 66 GF30 Polyamide 66 GF30	7807259 7807260 7807341	50 50 50
 Klemmdichtring Clamp sealing	NW 17 NW 22 NW 29	schwarz black	Neopren Neoprene	8117179 8117225 8117292	50 50 50
 Wellenschlauch Corrugated tube	NW 17 NW 22 NW 29				
 Überwurfmutter Cap nut	NW 17 NW 22 NW 29	grau grey	Polyamid Polyamide	9800697 9800905 9801138	50 50 50

35-poliger Stecker/Steckdose SEAL

35-pole Plug/Socket SEAL



IP 67

Material:
Polyamid 66
30 % glasfaserverstärkt
Silikon

Temperaturbereich:
-40°C bis 105°C
Bei Verwendung mit Zubehör bitte die jeweiligen Zubehör-Temperaturangaben beachten.

Farbe(n)/Ausführungen:
• schwarz

- Eigenschaften:**
- ähnlich VG 95234
- Zubehör (siehe Kapitel 5.2):**
- Kontakte
 - Seals
 - Werkzeuge
- Anwendungsbereiche:**
- NFZ
 - Landmaschinen
 - Baumaschinen



**Stecker
Plug**



**Steckdose
Socket**

- Material:**
Polyamide 66
30 % glassfibre reinforced
Silicone
- Temperature range:**
-40°C to 105°C
When used with accessories
please mind the respective accessory
temperature data.
- Colour(s)/Designs:**
• black

- Charecteristics:**
- similar to VG 95234
- Accessories (see chapter 5.2):**
- Contacts
 - Seals
 - Tools
- Applications:**
- Heavy trucks
 - Agricultural machines
 - Construction machines

Bezeichnung	Description	Farbe Colour	Art.-Nr. Art. no.	VE Stck. PU pcs.
35-pol. Stecker-Stiftgehäuse Kontaktbelegung: 26 x Stiftkontakt Ø: 1,6 mm 9 x Stiftkontakt Ø: 3,5 mm	35-pole plug-pin housing contacts: 26 x pin contact Ø: 1,6 mm 9 x pin contact Ø: 3,5 mm	schwarz black	7811222	50
35-pol. Stecker-Buchsengehäuse Kontaktbelegung: 26 x Buchsenkontakt Ø: 1,6 mm 9 x Buchsenkontakt Ø: 3,5 mm	35-pole plug-jack housing contacts: 26 x jack contact Ø: 1,6 mm 9 x jack contact Ø: 3,5 mm	schwarz black	7812226	50
35-pol. Steckdose-Stiftgehäuse Kontaktbelegung: 26 x Stiftkontakt Ø: 1,6 mm 9 x Stiftkontakt Ø: 3,5 mm	35-pole socket-pin housing contacts: 26 x pin contact Ø: 1,6 mm 9 x pin contact Ø: 3,5 mm	schwarz black	7811230	50
35-pol. Steckdose-Buchsengehäuse Kontaktbelegung: 26 x Buchsenkontakt Ø: 1,6 mm 9 x Buchsenkontakt Ø: 3,5 mm	35-pole socket-jack housing contacts: 26 x jack contact Ø: 1,6 mm 9 x jack contact Ø: 3,5 mm	schwarz black	7812218	50

37-poliger Stecker SEAL

37-pole Plug SEAL



IP 67

Material:

Polyamid 66
30 % glasfaserverstärkt
Perbunan
Silikon

Temperaturbereich:

-40°C bis 105°C
Bei Verwendung mit Zubehör bitte die jeweiligen Zubehör-Temperaturangaben beachten.

Farbe(n)/Ausführungen:

- schwarz
- Sonderstecker auf Anfrage

Eigenschaften:

- ähnlich VG 95234

Zubehör (siehe Kapitel...):

- Kontakte (5.2)
- Seals (5.2)
- Werkzeuge (5.2)
- Adapter (5.3)
- 90°-Winkel (5.3)
- Staubkappe (5.3)

Anwendungsbereiche:

- NFZ
- Landmaschinen
- Baumaschinen

Material:

Polyamide 66
30 % glassfibre reinforced
Perbunan
Silicone

Temperature range:

-40°C to 105°C
When used with accessories please mind the respective accessory temperature data.

Colour(s)/Designs:

- black
- special plug on request

Stecker
Plug



Characteristics:

- similar to VG 95234

Accessories (see chapter...):

- Contacts (5.2)
- Seals (5.2)
- Tools (5.2)
- Adaptor (5.3)
- 90°-angle (5.3)
- Dust cap (5.3)

Applications:

- Heavy trucks
- Agricultural machines
- Construction machines

5.2

Bezeichnung	Description	Farbe Colour	Art.-Nr. Art. no.	VE Stck. PU pcs.
37-pol. Stecker SEAL-fähig Kontaktbelegung: 37 x Stift- oder Buchsenkontakt Ø 1,6 mm	37-pole plug-pin housing suitable for SEAL contacts: 37 x pin or jack contact Ø 1,6 mm	schwarz black	7811375	50









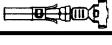

Kontakte /SEALS/Werkzeuge für SEAL-Steckverbinder

Contacts /SEALS/Tools for SEAL Connectors

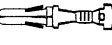
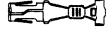
Material:
Bronze
Oberfläche verzinkt

Material:
Bronze
Surface tin-plated

4-pol

	Ø Kontakt- kammer mm Ø Contact cavity mm	Einzelkontakt Single Contact		Bandware Strip material		Querschnitt FLR-Leitung in mm ² Cross section FLR-wire (mm ²)	Buchsengehäuse ohne Druckausgleich	Buchsengehäuse mit Druckausgleich
		Art.-Nr. Art. no.	VE Stck. PU pcs.	Art.-Nr. Art. no.	VE Stck. PU pcs.		jack housing without pressure compensation	jack housing with pressure compensation
Kontakte/Contacts								
	6,7 *	7814125	1	7814123	2700	0,5 - 1,0	●	
		7814126	1	7814124	2700	1,5 - 2,5	●	
	4,0 **	7815045	1	7815046	4000	0,75 - 1,5		
		7814045	1	7814046	4500	0,75 - 1,5		
	5,2 ***	7815050	1	7815053	4000	0,5 - 1,0		
		7815051	1	7815052	4000	1,5 - 2,5		
		7814050	1	7814053	4000	0,5 - 1,0		
		7814051	1	7814052	4000	1,5 - 2,5		
	5,2 ****	7815047	1	7815049	3000	0,5 - 1,0		
		7815048	1	7815054	3000	1,5 - 2,5		
		7814047	1	7814049	3000	0,5 - 1,0		
		7814048	1	7814054	3000	1,5 - 2,5		
SEALS								
	4,0	7814137	1			0,75 - 1,0		
		7814138	1			1,5		
	5,2	7814140	1			0,35 - 1,0		
		7814141	1			1,5 - 2,5		
	6,7	7814128	1			0,35 - 1,0	●	
		7814129	1			1,5 - 2,5	●	
Blind-SEALS								
	4,0	7814135	1					
	5,2	7814136	1					
	6,7	7814130	1				●	

Passende Handcrimpzangen / Suitable hand crimping pliers

- * 7814146
- ** 7814145
- *** 7814147
- **** 7814148

3-poliger Steckverbinder nicht SEAL

3-pole Connector non SEAL



IP 67

Material:
Polyamid 66
Neopren
Weich-PVC

Temperaturbereich:
-35°C bis 100°C
Bei Verwendung mit Zubehör bitte die jeweiligen Zubehör-Temperaturangaben beachten.

Farbe(n)/Ausführungen:
• Farben: s. Tabelle
• Montagepackungen ab 100 Stück auf Anfrage

Zubehör (siehe Kapitel...):

- Kontakte (5.2)
- Werkzeuge (5.2)
- Überwurfmutter (5.3)
- Dichtungspuffer (5.3)
- Plombiering optional
- Einzeladerabdichtung (5.3)
- Klemmdichtring (5.3)

Anwendungsbereiche:

- NFZ
- Landmaschinen
- Baumaschinen



Buchsengehäuse
Jack housing



Stiftgehäuse
Pin housing

Material:
Polyamid 66
Neoprene
Soft-PVC

Temperature range:
-35°C to 100°C
When used with accessories please mind the respective accessory temperature data.

Colour(s)/Designs:

- Colours: s. table
- Assembly packages from 100 pcs on request





Accessories (see chapter...):

- Contacts (5.2)
- Tools (5.2)
- Cap nut (5.3)
- Sealing buffer (5.3)
- Locking ring optional
- Single wire sealing (5.3)
- Clamp sealing (5.3)

Applications:

- Heavy trucks
- Agricultural machines
- Construction machines

5.2

Bezeichnung Description		für for	Farbe Colour	Material Material	Art.-Nr. Art. no.	VE Stck. PU pcs.
 Überwurfmutter Cap nut		NW 10	grau grey	Polyamid Polyamide	9800689	50
 Dichtungspuffer Sealing buffer		Ø 3,2 mm Ø 4,5 mm Ø 5,6 mm	schwarz black	Neopren Neoprene	8115517 8115516 8115508	50 50 50
 oder/or Dichtungseinsatz Sealing insert		Ø 7 - 10,5 mm	grün green	Weich-PVC Soft-PVC	8115605	100
 Kabel Cable		Kabel Ø 4,5 mm Cable Ø 4,5 mm Kabel Ø 5,6 mm Cable Ø 5,6 mm				
 3-pol. Buchsengehäuse PG11 3-pole jack housing PG11		für Kontakt Ø 3,5 mm for contact Ø 3,5 mm	natur natural	Polyamid 66 Neopren Polyamide 66 Neoprene	7801017	50
 optional Plombiering optional Locking ring		optional optional	natur natural	Polyamid 66 Polyamide 66	7704534	50
 3-pol. Stiftgehäuse PG11 3-pole pin housing PG11		für Kontakt Ø 3,5 mm for contact Ø 3,5 mm	natur natural	Polyamid 66 Polyamide 66	7801009	50
 optional Einzeladerabdichtung optional Single wire sealing		optional optional	schwarz black	Neopren Neoprene	8113647	50
 Klemmdichtring Clamp sealing		NW 8,5 NW 10	schwarz black	Neopren Neoprene	8117080 8117101	50 50
 Wellenschlauch Corrugated tube		NW 8,5 NW 10				
 Überwurfmutter Cap nut		NW 8,5 NW 10	grau grey	Polyamid Polyamide	9801324 9800689	50 50

5-poliger Steckverbinder

nicht SEAL

5-pole Connector

non SEAL



Material:
Polyamid 6
Neopren
Perbunan

Temperaturbereich:
-40°C bis 105°C
Bei Verwendung mit Zubehör bitte die jeweiligen Zubehör-Temperaturangaben beachten.

Farbe(n)/Ausführungen:

- schwarz/grau
- gerade
- Montagepackungen ab 100 Stück auf Anfrage

Eigenschaften:

- Kontaktsystem Ø: 1,6 mm

Zubehör (siehe Kapitel...):

- Kontakte (5.2)
- Werkzeuge (5.2)
- Überwurfmutter (5.3)
- Klemmdichtring (5.3)

Anwendungsbereiche:

- NFZ
- Landmaschinen
- Baumaschinen



Material:
Polyamide 6
Neoprene
Perbunan

Temperature range:
-40°C to 105°C
When used with accessories please mind the respective accessory temperature data.

Colour(s)/Designs:

- black/grey
- straight
- Assembly packages from 100 pcs on request

Characteristics:





- Contact system Ø: 1,6 mm

Accessories (see chapter...):

- Contacts (5.2)
- Tools (5.2)
- Cap nut (5.3)
- Clamp sealing (5.3)

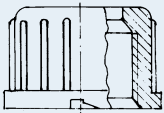
Applications:

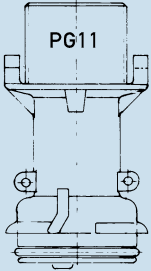
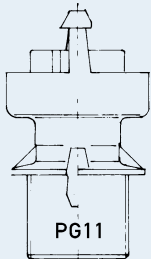
- Heavy trucks
- Agricultural machines
- Construction machines

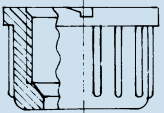
Bezeichnung Description	für for	Farbe Colour	Material Material	Art.-Nr. Art. no.	VE Stck. PU pcs.
 <p>Überwurfmutter Cap nut</p>	NW 8,5	grau grey	Polyamid Polyamide	9801324	50
	NW 10			9800689	50
 <p>Wellschlauch Corrugated tube</p>	NW 8,5 NW 10				
 <p>Klemmdichtring Clamp sealing</p>	NW 8,5	schwarz black	Neopren Neoprene	8117080	50
	NW 10			8117101	50
 <p>5-pol. Stiftgehäuse PG11 5-pole pin housing PG11</p>	für Kontakt for contact Ø 1,6 mm	schwarz black	Polyamid 6 Perbunan Polyamide 6 Perbunan	7806043	50
 <p>5-pol. Buchsengehäuse PG11 5-pole jack housing PG11</p>	für Kontakt for contact Ø 1,6 mm	schwarz black	Polyamid 6 Polyamide 6	7805047	50
 <p>Klemmdichtring Clamp sealing</p>	NW 8,5	schwarz black	Neopren Neoprene	8117080	50
	NW 10			8117101	50
 <p>Wellschlauch Corrugated tube</p>	NW 8,5 NW 10				
 <p>Überwurfmutter Cap nut</p>	NW 8,5	grau grey	Polyamid 6 Polyamide 6	9801324	50
	NW 10			9800689	50

8-poliger Steckverbinder

nicht SEAL für Flanschmontage

8-pole Connector

non SEAL for Flange Assembly



IP 67

Material:
Polyamid 6
Neopren
Silikon

Temperaturbereich:

-40°C bis 105°C

Bei Verwendung mit Zubehör bitte die jeweiligen Zubehör-Temperaturangaben beachten.

Farbe(n)/Ausführungen:

- Farben: s. Tabelle
- Montagepackungen ab 100 Stück auf Anfrage

Eigenschaften:

- Kontaktbelegung
7 x Kontakt Ø: 1,6 mm
1 x Kontakt Ø: 3,5 mm
an Position '8'

oder:

8 x Kontakt Ø: 1,6 mm

Zubehör (siehe Kapitel...):

- Kontakte (5.2)
- Werkzeuge (5.2)
- Überwurfmutter (5.3)
- Klemmdichtring (5.3)
- Einzelerabdichtung (5.3)
- Flachdichtung (5.3)
- Flansch

Anwendungsbereiche:

- NFZ
- Landmaschinen
- Baumaschinen



Gerader Kegel Straight cone **Winkelkegel** Angle cone **Stiftgehäuse** Pin housing **Buchsengehäuse** Jack housing

Material:

Polyamide 6
Neoprene
Silicone

Temperature range:

-40°C to 105°C

When used with accessories please mind the respective accessory temperature data.

Colour(s)/Designs:

- Colours: s. table
- Assembly packages from 100 pcs on request

Characteristics:

- Contacts:
7 x contact Ø: 1,6 mm
1 x contact Ø: 3,5 mm
on position '8'

or:







8 x contact Ø: 1,6 mm

Accessories (see chapter...):

- Contacts (5.2)
- Tools (5.2)
- Cap nut (5.3)
- Clamp sealing (5.3)
- Single wire sealing (5.3)
- Flat sealing (5.3)
- Flange

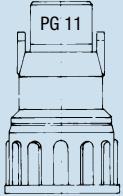
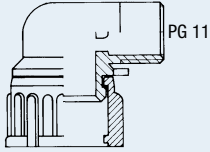
Applications:

- Heavy trucks
- Agricultural machines
- Construction machines

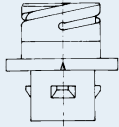
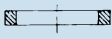
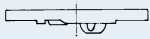
Bezeichnung Description	für for	Farbe Colour	Material Material	Art.-Nr. Art. no.	VE Stck. PU pcs.
 Überwurfmutter Cap nut	NW 10	grau grey	Polyamid Polyamide	9800689	50
 Wellschlauch Corrugated tube	NW 10				
 Klemmdichtring Clamp sealing	NW 10	schwarz black	Neopren Neoprene	8117101	50
 Gerader Kegel PG11 mit Bajonett 16 S ähnlich VG 95234 Straight cone PG11 with bayonet 16 S similar VG 95234		schwarz black	Polyamid 6 Polyamide 6	9800611	50
 Winkelkegel PG11 mit Bajonett 16 S Angle cone PG11 with bayonet 16 S		schwarz black	Polyamid 6 Polyamide 6	9800603	50
 Einzelerabdichtung Single wire sealing		rotbraun red-brown	Silikon Silicone	8113646	50
 8-pol. Buchsengehäuse 8-pole jack housing	Kontaktbelegung/contacts: 7 x Ø 1,6 mm 1 x Ø 3,5 mm oder/or 8 x Ø 1,6 mm	schwarz black	Polyamid 6 Polyamide 6	7805098	50
 Flachdichtung Flat sealing		schwarz black	Neopren Neoprene	8113424	50
 8-pol. Stiftgehäuse mit Bajonett 16 S ähnlich VG 95234 8-pole pin housing with bayonet 16 S similar to VG 95234	Kontaktbelegung/contacts: 7 x Ø 1,6 mm 1 x Ø 3,5 mm oder/or 8 x Ø 1,6 mm	schwarz black	Polyamid 6 Polyamide 6	7806388	50
 Flachdichtung Flat sealing		natur natural	Silikon Silicone	7813032	50
 Flansch Flange		schwarz black	Polyamid 6 Polyamide 6	7813015	50

8-poliger Steckverbinder

nicht SEAL für Wellenschlauchanschluss

8-pole Connector

non SEAL for corrugated Tube Assembly



Material:
Polyamid 6
Neopren
Silikon

Temperaturbereich:
-40°C bis 105°C

Bei Verwendung mit Zubehör bitte die jeweiligen Zubehör-Temperaturangaben beachten.

Farbe(n)/Ausführungen:

- Farben: s. Tabelle
- Montagepackungen ab 100 Stück auf Anfrage

Eigenschaften:

- Kontaktbelegung
7 x Kontakt Ø: 1,6 mm
1 x Kontakt Ø: 3,5 mm
an Position '8'
- oder:
8 x Kontakt Ø: 1,6 mm

Zubehör (siehe Kapitel...):

- Kontakte (5.2)
- Werkzeuge (5.2)
- Überwurfmutter (5.3)
- Klemmdichtring (5.3)
- Einzelerabdichtung (5.3)
- Flachdichtung (5.3)

Anwendungsbereiche:

- NFZ
- Landmaschinen
- Baumaschinen

Material:
Polyamide 6
Neoprene
Silicone

Temperature range:
-40°C to 105°C

When used with accessories please mind the respective accessory temperature data.

Colour(s)/Designs:

- Colours: s. table
- Assembly packages from 100 pcs on request

Characteristics:

- Contacts:
7 x contact Ø: 1,6 mm
1 x contact Ø: 3,5 mm
on position '8'
- or:
8 x contact Ø: 1,6 mm



Accessories (see chapter...):

- Contacts (5.2)
- Tools (5.2)
- Cap nut (5.3)
- Clamp sealing (5.3)
- Single wire sealing (5.3)
- Flat sealing (5.3)

Applications:

- Heavy trucks
- Agricultural machines
- Construction machines

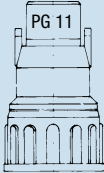
5.2

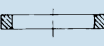
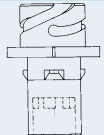
Bezeichnung Description	für for	Farbe Colour	Material Material	Art.-Nr. Art. no.	VE Stck. PU pcs.
 Überwurfmutter Cap nut	NW 10	grau grey	Polyamid Polyamide	9800689	50
 Wellenschlauch Corrugated tube	NW 10				
 Klemmdichtring Clamp sealing	NW 10	schwarz black	Neopren Neoprene	8117101	50
 Gerader Kegel PG11 mit Bajonett 16 S ähnlich VG 95234 Straight cone PG11 with bayonet 16 S similar VG 95234		schwarz black	Polyamid 6 Polyamide 6	9800611	50
 Winkelkegel PG11 mit Bajonett 16 S Angle cone PG11 with bayonet 16 S		schwarz black	Polyamid 6 Polyamide 6	9800603	50
 Einzelerabdichtung Single wire sealing		rotbraun red-brown	Silikon Silicone	8113646	50
 8-pol. Buchsengehäuse 8-pole jack housing	Kontaktbelegung/contacts: 7 x Ø 1,6 mm/1 x Ø 3,5 mm	schwarz black	Polyamid 6 Polyamide 6	7805098	50
	oder/or: 8 x Ø 1,6 mm			7805080	50
 Flachdichtung Flat sealing		schwarz black	Neopren Neoprene	8113424	50
 8-pol. Stiftgehäuse mit Bajonett 16 S 8-pole pin housing with bayonet 16 S	Kontaktbelegung/contacts: 7 x Ø 1,6 mm 1 x Ø 3,5 mm	schwarz black	Polyamid 6 Polyamide 6	9800573	50
	oder/or: 8 x Ø 1,6 mm			7806051	50
 Klemmdichtring Clamp sealing	NW 13	schwarz black	Neopren Neoprene	8117136	50
 Wellenschlauch Corrugated tube	NW 13				
 Überwurfmutter Cap nut	NW 13	grau grey	Polyamid 6 Polyamide 6	9800956	50

16-poliger Steckverbinder

nicht SEAL
(Aufbau)

16-pole Connector

non SEAL
(Assembling)



IP 67

Material:
Polyamid 6/66
30 % glasfaserverstärkt
Neopren
Perbunan
Polycarbonat
Silikon

Temperaturbereich:
-40°C bis 105°C
Bei Verwendung mit Zubehör bitte die jeweiligen Zubehör-Temperaturangaben beachten.

Farbe(n)/Ausführungen:
• Farben: s. Tabelle
• Montagepackungen ab 100 Stück auf Anfrage

Eigenschaften:
• ähnlich VG 95234
Zubehör (siehe Kapitel...):
• Kontakte (5.2)
• Werkzeuge (5.2)
• Überwurfmutter (5.3)
• Klemmdichtring (5.3)
• Adapter (5.3)
• Druckplatte (5.3)
• Dichtscheibe (5.3)
• Zentrierscheibe (5.3)
Anwendungsbereiche:
• NFZ
• Landmaschinen
• Baumaschinen



Steckdose
Socket



Stecker
Plug

Material:
Polyamide 6/66
30 % glassfibre reinforced
Neoprene
Perbunan
Polycarbonate
Silicone
Temperature range:
-40°C to 105°C
When used with accessories please mind the respective accessory temperature data.
Colour(s)/Designs:
• Colours: s. table
• Assembly packages from 100 pcs on request

Characteristics:
• similar to VG 95234
Accessories (see chapter...):
• Contacts (5.2)
• Tools (5.2)
• Cap nut (5.3)
• Clamp sealing (5.3)
• Adaptor (5.3)
• Pressure plate (5.3)
• Sealing plate (5.3)
• Center plate (5.3)
Applications:
• Heavy trucks
• Agricultural machines
• Construction machines

Bezeichnung Description		für for	Farbe Colour	Material Material	Art.-Nr. Art. no.	VE Stck. PU pcs.
Überwurfmutter Cap nut		NW 22	grau grey	Polyamid Polyamide	9800905	50
Klemmdichtring Clamp sealing		NW 22	schwarz black	Neopren Neoprene	8117225	50
Well Schlauch Corrugated tube		NW 22				
Adapter Adaptor		NW 22	schwarz black	Polyamid 66 GF 30 Polyamide 66 GF 30	7807163	50
Druckplatte Pressure plate			schwarz black	Polyamid 6 Polyamide 6	7810394	50
Dichtscheibe Sealing plate			transparent transparent	Silikon Silicone	7810164	50
Stecker - Stiftgehäuse Plug - pin housing			schwarz black	Polyamid 66 GF 30 Perbunan, Silikon	7811160	50
Stecker - Buchsengehäuse Plug - jack housing				Polyamid 66 GF 30 Perbunan, Silikon	7812162	50
optional Zentrierscheibe optional Center plate		optional optional	transparent transparent	Polycarbonat Polycarbonate	7810400	50
Steckdose - Buchsengehäuse Socket - jack housing			schwarz black	Polyamid 66 GF 30 Perbunan	7812167	50
Steckdose - Stiftgehäuse Socket - pin housing				Polyamid 66 GF 30 Perbunan	7811163	50
Dichtscheibe Sealing plate			transparent transparent	Silikon Silicone	7810164	50
Druckplatte Pressure plate			schwarz black	Polyamid 6 Polyamide 6	7810394	50
Adapter Adaptor		NW 22	schwarz black	Polyamid 66 GF 30 Polyamide 66 GF 30	7807163	50
Klemmdichtring Clamp sealing		NW 22	schwarz black	Neopren Neoprene	8117225	50
Well Schlauch Corrugated tube		NW 22				
Überwurfmutter Cap nut		NW 22	grau grey	Polyamid Polyamide	9800905	50

16-poliger Stecker/Steckdose

nicht SEAL

16-pole Plug/Socket

non SEAL



IP 67

Material:
Polyamid 66
30 % glasfaserverstärkt
Perbunan
Silikon

Temperaturbereich:
-40°C bis 105°C
Bei Verwendung mit Zubehör bitte die jeweiligen Zubehör-Temperaturangaben beachten.

Farbe(n)/Ausführungen:
• schwarz

Eigenschaften:
• ähnlich VG 95234
Zubehör (siehe Kapitel 5.2):
• Kontakte
• Werkzeuge

Anwendungsbereiche:
• NFZ
• Landmaschinen
• Baumaschinen



**Stecker
Plug**



**Steckdose
Socket**

Material:
Polyamide 66
30 % glassfibre reinforced
Perbunan
Silicone
Temperature range:
-40°C to 105°C
When used with accessories please mind the respective accessory temperature data.
Colour(s)/Designs:
• black

Characteritics:
• similar to VG 95234
Accessories (see chapter 5.2):
• Contacts
• Tools
Applications:
• Heavy trucks
• Agricultural machines
• Construction machines

Bezeichnung	Description	Farbe Colour	Art.-Nr. Art. no.	VE Stck. PU pcs.
16-pol. Stecker - Stiftgehäuse Kontaktbelegung: 12 x Stiftkontakt Ø: 1,6 mm 4 x Stiftkontakt Ø: 3,5 mm	16-pole plug - pin housing contacts: 12 x pin contact Ø: 1,6 mm 4 x pin contact Ø: 3,5 mm	schwarz black	7811160	50
16-pol. Stecker - Buchsengehäuse Kontaktbelegung: 12 x Buchsenkontakt Ø: 1,6 mm 4 x Buchsenkontakt Ø: 3,5 mm	16-pole plug - jack housing contacts: 12 x jack contact Ø: 1,6 mm 4 x jack contact Ø: 3,5 mm	schwarz black	7812162	50
16-pol. Steckdose - Stiftgehäuse Kontaktbelegung: 12 x Stiftkontakt Ø: 1,6 mm 4 x Stiftkontakt Ø: 3,5 mm	16-pole socket - pin housing contacts: 12 x pin contact Ø: 1,6 mm 4 x pin contact Ø: 3,5 mm	schwarz black	7811163	50
16-pol. Steckdose - Buchsengehäuse Kontaktbelegung: 12 x Buchsenkontakt Ø: 1,6 mm 4 x Buchsenkontakt Ø: 3,5 mm	16-pole socket - jack housing contacts: 12 x jack contact Ø: 1,6 mm 4 x jack contact Ø: 3,5 mm	schwarz black	7812167	50

21-poliger Steckverbinder

nicht SEAL (Aufbau)

21-pole Connector

non SEAL (Assembly)



Material:
Polyamid 6/66
30 % glasfaserverstärkt
Neopren
Perbunan
Polycarbonat
Silikon

Temperaturbereich:
-40°C bis 105°C
Bei Verwendung mit Zubehör bitte die jeweiligen Zubehör-Temperaturangaben beachten.

Farbe(n)/Ausführungen:
• Farben: s. Tabelle
• Montagepackungen ab 100 Stück auf Anfrage

Eigenschaften:
• ähnlich VG 95234

Zubehör (siehe Kapitel...):

- Kontakte (5.2)
- Werkzeuge (5.2)
- Überwurfmutter (5.3)
- Klemmdichtring (5.3)
- Adapter (5.3)
- 90°-Winkel (5.3)
- Zentrierscheibe (5.3)
- Druckplatte (5.3)
- Dichtscheibe (5.3)
- Staubkappe (5.3)

Anwendungsbereiche:

- NFZ
- Landmaschinen
- Baumaschinen



Stecker Plug



Steckdose Socket

Material:
Polyamid 6/66
30 % glassfibre reinforced
Neoprene
Perbunan
Polycarbonate
Silicone

Temperature range:
-40°C to 105°C
When used with accessories please mind the respective accessory temperature data.

Colour(s)/Designs:

- Colours: s. table
- Assembly packages from 100 pcs on request

Characteristics:

- similar to VG 95234

Accessories (see chapter...):

- Contacts (5.2)
- Tools (5.2)
- Cap nut (5.3)
- Clamp sealing (5.3)
- Adaptor (5.3)
- 90°-angle (5.3)
- Center plate (5.3)
- Pressure plate (5.3)
- Sealing plate (5.3)
- Dust cap (5.3)

Applications:

- Heavy trucks
- Agricultural machines
- Construction machines

Bezeichnung Description		für for	Farbe Colour	Material Material	Art.-Nr. Art. no.	VE Stck. PU pcs.
Überwurfmutter Cap nut		NW 17 NW 22 NW 29	grau grey	Polyamid Polyamide	9800697 9800905 9801138	50 50 50
Klemmdichtring Clamp sealing		NW 17 NW 22 NW 29	schwarz black	Neopren Neoprene	8117179 8117225 8117292	50 50 50
Wellschlauch Corrugated tube		NW 17 NW 22 NW 29				
Adapter Adaptor		NW 17 NW 22 NW 29	schwarz black	Polyamid 66 GF 30 Polyamide 66 GF 30	7807259 7807260 7807341	50 50 50
Druckplatte Pressure plate			schwarz black	Polyamid 6 Polyamide 6	7810393	50
Dichtscheibe Sealing plate			transparent transparent	Silikon Silicone	7810210	50
Stecker - Stiftgehäuse Plug - pin housing			schwarz black	Polyamid 66 GF 30 Perbunan, Silikon Polyamide 66 GF 30 Perbunan, Silicone	7811217	50
Stecker - Buchsengehäuse Plug - jack housing					7812221	50
optional Zentrierscheibe optional Center plate		optional optional	transparent transparent	Polycarbonat Polycarbonate	7810401	50
Steckdose - Buchsengehäuse Socket - jack housing			schwarz black	Polyamid 66 GF 30 Perbunan Polyamide 66 GF 30 Perbunan	7812213	50
Steckdose - Stiftgehäuse Socket - pin housing					7811225	50
Dichtscheibe Sealing plate			transparent transparent	Silikon Silicone	7810210	50
Druckplatte Pressure plate			schwarz black	Polyamid 6 Polyamide 6	7810393	50
Adapter Adaptor		NW 17 NW 22 NW 29	schwarz black	Polyamid 66 GF 30 Polyamide 66 GF 30	7807259 7807260 7807341	50 50 50
Klemmdichtring Clamp sealing	} oder/or: 90°-Winkel 90°-angle	NW 17 NW 22 NW 29	schwarz black	Neopren Neoprene	8117179 8117225 8117292	50 50 50
Wellschlauch Corrugated tube		NW 17 NW 22 NW 29				
Überwurfmutter Cap nut		NW 17 NW 22 NW 29	grau grey	Polyamid Polyamide	9800697 9800905 9801138	50 50 50

**21-poliger
Stecker/Steckdose**
nicht SEAL

**21-pole
Plug/Socket**
non SEAL



Material:
Polyamid 66
30 % glasfaserverstärkt
Perbunan
Silikon

Temperaturbereich:
-40°C bis 105°C
Bei Verwendung mit Zubehör bitte die jeweiligen Zubehör-Temperaturangaben beachten.

Farbe(n)/Ausführungen:
• schwarz

Eigenschaften:
• ähnlich VG 95234
Zubehör (siehe Kapitel 5.2):
• Kontakte
• Werkzeuge

Anwendungsbereiche:
• NFZ
• Landmaschinen
• Baumaschinen



**Stecker
Plug**



**Steckdose
Socket**

Material:
Polyamide 66
30 % glassfibre reinforced
Perbunan
Silicone
Temperature range:
-40°C to 105°C
When used with accessories please mind the respective accessory temperature data.
Colour(s)/Designs:
• black

Characteristics:
• similar to VG 95234
Accessories (see chapter 5.2):
• Contacts
• Tools
Applications:
• Heavy trucks
• Agricultural machines
• Construction machines

Bezeichnung	Description	Farbe Colour	Art.-Nr. Art. no.	VE Stck. PU pcs.
21-pol. Stecker - Stiftgehäuse Kontaktbelegung: 14 x Stiftkontakt Ø: 1,6 mm 7 x Stiftkontakt Ø: 3,5 mm	21-pole plug - pin housing contacts: 14 x pin contact Ø: 1,6 mm 7 x pin contact Ø: 3,5 mm	schwarz black	7811217	50
21-pol. Stecker - Buchsengehäuse Kontaktbelegung: 14 x Buchsenkontakt Ø: 1,6 mm 7 x Buchsenkontakt Ø: 3,5 mm	21-pole plug - jack housing contacts: 14 x jack contact Ø: 1,6 mm 7 x jack contact Ø: 3,5 mm	schwarz black	7812221	50
21-pol. Steckdose - Stiftgehäuse Kontaktbelegung: 14 x Stiftkontakt Ø: 1,6 mm 7 x Stiftkontakt Ø: 3,5 mm	21-pole socket - pin housing contacts: 14 x pin contact Ø: 1,6 mm 7 x pin contact Ø: 3,5 mm	schwarz black	7811225	50
21-pol. Steckdose - Buchsengehäuse Kontaktbelegung: 14 x Buchsenkontakt Ø: 1,6 mm 7 x Buchsenkontakt Ø: 3,5 mm	21-pole socket - jack housing contacts: 14 x jack contact Ø: 1,6 mm 7 x jack contact Ø: 3,5 mm	schwarz black	7812213	50

37-poliger Steckverbinder

nicht SEAL
(Aufbau)

37-pole Connector

non SEAL
(Assembling)



Material:
Polyamid 6/66
30 % glasfaserverstärkt
Neopren
Perbunan
Polycarbonat
Silikon

Temperaturbereich:
-40°C bis 105°C
Bei Verwendung mit Zubehör bitte die jeweiligen Zubehör-Temperaturangaben beachten.

Farbe(n)/Ausführungen:
• Farben: s. Tabelle
• Montagepackungen ab 100 Stück auf Anfrage

Eigenschaften:
• Stecker auch für SEAL verfügbar
• ähnlich VG 95234

Zubehör (siehe Kapitel...):
• Kontakte (5.2)
• Werkzeuge (5.2)
• Überwurfmutter (5.3)
• Klemmdichtring (5.3)
• Adapter (5.3)
• 90°-Winkel (5.3)
• Zentrierscheibe (5.3)
• Druckplatte (5.3)
• Dichtscheibe (5.3)
• Staubkappe (5.3)

Anwendungsbereiche:
• NFZ
• Landmaschinen
• Baumaschinen



Stecker
Plug



Steckdose
Socket

Material:
Polyamide 6/66
30 % glassfibre reinforced
Neoprene
Perbunan
Polycarbonate
Silicone

Temperature range:
-40°C to 105°C
When used with accessories please mind the respective accessory temperature data.

Colour(s)/Designs:
• Colours: s. table
• Assembly packages from 100 pcs on request

Characteristics:
• Plug also available for SEAL
• similar to VG 95234

Accessories (see chapter...):
• Contacts (5.2)
• Tools (5.2)
• Cap nut (5.3)
• Clamp sealing (5.3)
• Adaptor (5.3)
• 90°-angle (5.3)
• Center plate (5.3)
• Pressure plate (5.3)
• Sealing plate (5.3)
• Dust cap (5.3)

Applications:
• Heavy trucks
• Agricultural machines
• Construction machines

Bezeichnung Description		für for	Farbe Colour	Material Material	Art.-Nr. Art. no.	VE Stck. PU pcs.
Überwurfmutter Cap nut		NW 17 NW 22 NW 29	grau grey	Polyamid Polyamide	9800697 9800905 9801138	50 50 50
Wellenschlauch Corrugated tube		NW 17 NW 22 NW 29				
Klemmdichtring Clamp sealing		NW 17 NW 22 NW 29	schwarz black	Neopren Neoprene	8117179 8117225 8117292	50 50 50
Adapter Adaptor		NW 17 NW 22 NW 29	schwarz black	Polyamid 66 GF 30 Polyamide 66 GF 30	7807259 7807260 7807341	50 50 50
Druckplatte Pressure plate			schwarz black	Polyamid 6 Polyamide 6	7810385	50
Dichtscheibe Sealing plate			transparent transparent	Silikon Silicone	7810377	50
37-pol. Stecker 37-pole plug			schwarz black	Polyamid 66 GF 30 Perbunan, Silikon Polyamide 66 GF 30 Perbunan, Silicone	7811373	50
Zentrierscheibe Center plate			transparent transparent	Polycarbonat Polycarbonate	7810402	50
37-pol. Steckdose 37-pole socket			schwarz black	Polyamid 66 GF 30 Perbunan Polyamide 66 GF 30 Perbunan	7812370	50
Dichtscheibe Sealing plate			transparent transparent	Silikon Silicone	7810377	50
Druckplatte Pressure plate			schwarz black	Polyamid 6 Polyamide 6	7810385	50
Adapter Adaptor		NW 17 NW 22 NW 29	schwarz black	Polyamid 66 GF 30 Polyamide 66 GF 30	7807259 7807260 7807341	50 50 50
Klemmdichtring Clamp sealing	} oder/or: 90°-Winkel 90°-angle	NW 17 NW 22 NW 29	schwarz black	Neopren Neoprene	8117179 8117225 8117292	50 50 50
Wellenschlauch Corrugated tube		NW 17 NW 22 NW 29				
Überwurfmutter Cap nut		NW 17 NW 22 NW 29	grau grey	Polyamid Polyamide	9800697 9800905 9801138	50 50 50

**37-poliger
Stecker/Steckdose**
nicht SEAL

**37-pole
Plug/Socket**
non SEAL



Material:
Polyamid 66
30 % glasfaserverstärkt
Perbunan
Silikon

Temperaturbereich:
-40°C bis 105°C
Bei Verwendung mit Zubehör bitte die jeweiligen Zubehör-Temperaturangaben beachten.

Farbe(n)/Ausführungen:

- schwarz
- Sonderstecker auf Anfrage

Eigenschaften:

- Stecker auch für SEAL verfügbar
- ähnlich VG 95234

Zubehör (siehe Kapitel 5.2):

- Kontakte
- Werkzeuge

Anwendungsbereiche:

- NFZ
- Landmaschinen
- Baumaschinen



**Stecker
Plug**



**Steckdose
Socket**

Material:
Polyamide 66
30 % glassfibre reinforced
Perbunan
Silicone

Temperature range:
-40°C to 105°C
When used with accessories please mind the respective accessory temperature data.

Colour(s)/Designs:

- black
- Special plug on request

Characteristics:

- Plug also available for SEAL
- similar to VG 95234

Accessories (see chapter 5.2):

- Contacts
- Tools

Applications:

- Heavy trucks
- Agricultural machines
- Construction machines

Bezeichnung	Description	Farbe Colour	Art.-Nr. Art. no.	VE Stck. PU pcs.
37-pol. Stecker Kontaktbelegung: 37 x Stift- oder Buchsenkontakt Ø 1,6 mm	37-pole plug contacts: 37 x pin or jack contact Ø 1,6 mm	schwarz black	7811373	50
37-pol. Steckdose Kontaktbelegung: 37 x Stift- oder Buchsenkontakt Ø 1,6 mm	37-pole socket contacts: 37 x pin or jack contact Ø 1,6 mm	schwarz black	7812370	50

5.2

Buchsenkontakte

für nicht SEAL und
3-pol. Sondersteckverbinder



Temperaturbereich:
-40°C bis 130°C

Eigenschaften:

- Einzelstrombelastbarkeit:
Steckverbindung Ø 1,6 mm = 13 A
Steckverbindung Ø 3,5 mm = 25 A
- Unmittelbar benachbarte Kontakte dürfen nur mit 50 % der max. Einzelstrombelastbarkeit beaufschlagt werden.

Jack contacts

for non SEAL and
3-pole Special Connectors



Temperature range:
-40°C to 130°C

Characteristics:

- Single load capacity:
Connector Ø 1,6 mm = 13 A
Connector Ø 3,5 mm = 25 A
- Directly nearby contacts are to be loaded with 50 % of single load capacity.

5.2

Ø	Nennquerschnitt	Einzelkontakt Art.-Nr.	VE Stck.	Bandware Art.-Nr.	VE Stck.
Ø	Nominal cross section	Single contact Art. no.	PU pcs.	Strip material Art. no	PU pcs.
1,6 mm	0,5 - 1,0 mm ²	7814009	1	7702954	4500
1,6 mm	>1,0 - 2,5 mm ²	7814011	1	7814012	3500
3,5 mm	>1,0 - 2,5 mm ²	7702957	1	7702959	3000
3,5 mm	>2,5 - 6,0 mm ²	7814038	1	7814039	3000

Stiftkontakte

für nicht SEAL und
3-pol. Sondersteckverbinder



Temperaturbereich:
-40°C bis 130°C

Eigenschaften:

- Einzelstrombelastbarkeit:
Steckverbindung Ø 1,6 mm = 13 A
Steckverbindung Ø 3,5 mm = 25 A
- Unmittelbar benachbarte Kontakte dürfen nur mit 50 % der max. Einzelstrombelastbarkeit beaufschlagt werden.

Pin contacts

for non SEAL and
3-pole Special Connectors



Temperature range:
-40°C to 130°C

Characteristics:

- Single load capacity:
Connector Ø 1,6 mm = 13 A
Connector Ø 3,5 mm = 25 A
- Directly nearby contacts are to be loaded with 50 % of single load capacity.

Ø	Nennquerschnitt	Einzelkontakt Art.-Nr.	VE Stck.	Bandware Art.-Nr.	VE Stck.
Ø	Nominal cross section	Single contact Art. no.	PU pcs.	Strip material Art. no	PU pcs.
1,6 mm	0,5 - 1,0 mm ²	7815016	1	7702952	5000
1,6 mm	>1,0 - 2,5 mm ²	7815018	1	7702950	3000
3,5 mm	>1,0 - 2,5 mm ²	7702949	1	7815036	3000
3,5 mm	>2,5 - 6,0 mm ²	7815034	1	7815035	3000

**Werkzeuge für
Stift-/Buchsen-
kontakte**
nicht SEAL-Anwendungen

**Tools for
Pin-/Jack
contacts**
non SEAL-Applications

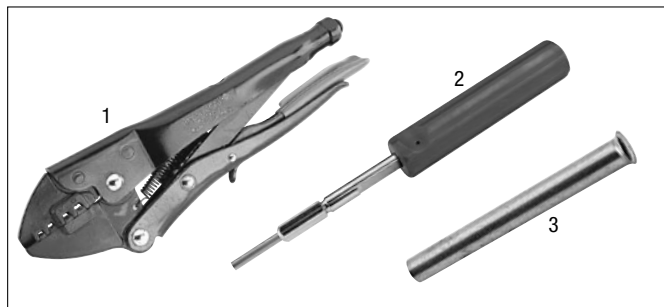

Weitere Werkzeuge auf Anfrage.

Further tools on request.

Bezeichnung Description	für Ø for Ø	Art.-Nr. Art. no.	VE Stck. PU pcs.
Handcrimpzange (1) Hand crimping pliers (1)	1,6 mm/3,5 mm	7704501	1
Entriegelungswerkzeug (2) Extraction tool (2)	1,6 mm	7704497	1
	3,5 mm	7704489	1
Ersatzhülsen für Entriegelungswerkzeug (3) Replacement sleeve for extraction tool (3)	1,6 mm	7704470	1
	3,5 mm	7704461	1

Sondersteckverbinder 3-polig

Special Connectors 3-pole



IP 67

Material:
Polyamid 6
Neopren
Perbunan

Temperaturbereich:
-40°C bis 105°C

Bei Verwendung mit Zubehör bitte die jeweiligen Zubehör-Temperaturangaben beachten.

Farbe(n)/Ausführungen:
• schwarz/grau

Eigenschaften:

- für Wellschlauch NW 10
- Gerader Kegel oder Winkelkegel

- mit Bajonett 10 SL
- mit Gewinde PG 11
- mit Gewinde M 18 x 1

Zubehör (siehe Kapitel...):

- Kontakte (5.2)
- Werkzeuge (5.2)
- Einzelerabdichtung (5.3)
- Klemmdichtring (5.3)
- Überwurfmutter (5.3)
- Blindverschluss

Anwendungsbereiche:

- NFZ
- Landmaschinen
- Baumaschinen



Gerader Kegel
Straight cone



Winkelkegel
Angle cone

Material:
Polyamid 6
Neopren
Perbunan

Temperature range:
-40°C to 105°C

When used with accessories please mind the respective accessory temperature data.

Colour(s)/Designs:
• black/grey

Characteristics:

- for corrugated tube NW 10
- Straight cone or angle cone







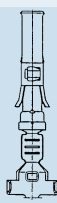
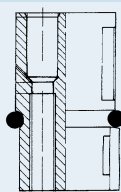
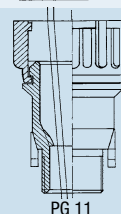

- with bayonet 10 SL
- with thread PG 11
- with thread M 18 x 1

Accessories (see chapter...):

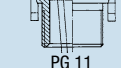
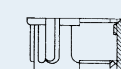
- Contacts (5.2)
- Tools (5.2)
- Single wire sealing (5.3)
- Clamp sealing (5.3)
- Cap nut (5.3)
- Blind plug

Applications:

- Heavy trucks
- Agricultural machines
- Construction machines

Bezeichnung Description	für for	Farbe Colour	Material Material	Art.-Nr. Art. no.	VE Stck. PU pcs.
optional Blindverschluss optional Blind plug	optional optional		Polyamid 6 Polyamide 6	7807380	50
 Buchsenkontakt Jack contact	Ø 1,6 mm			7814011	1
 3-poliges Buchsengehäuse 3-pole jack-housing		schwarz black	Polyamid 6 Polyamide 6	7805039	50
O-ring (separat bestellen) O-ring (order separately)			Perbunan Perbunan	8112495	1
 Gerader Kegel PG 11 mit Bajonett 10 SL Straight cone PG 11 with bayonet 10 SL		schwarz black	Polyamid 6 Polyamide 6	9800582	50
 Gerader Kegel PG 11 mit Gewinde PG 11 Straight cone PG 11 with thread PG 11				9800591	50
 Gerader Kegel PG 11 mit Gewinde M 18 x 1 Straight cone PG 11 with thread M 18 x 1				9800787	50
 oder/or: Winkelkegel PG 11 mit Bajonett 10 SL Angle cone PG 11 with bayonet 10 SL		schwarz black	Polyamid 6 Polyamide 6	9800581	50
 Winkelkegel PG 11 mit Gewinde PG 11 Angle cone PG 11 with thread PG 11				9800590	50
 Winkelkegel PG 11 mit Gewinde M 18 x 1 Angle cone PG 11 with thread M 18 x 1				9800786	50
 Einzelerabdichtung Single wire sealing		schwarz black	Neopren Neoprene	8113647	50
 Klemmdichtring Clamp sealing	NW 10	schwarz black	Neopren Neoprene	8117101	50
 Wellschlauch Corrugated tube	NW 10				
 Überwurfmutter Cap nut	NW 10	grau grey	Polyamid Polyamide	9800689	50

Montagepackungen Sondersteckverbinder 3-polig

Assembly Packages Special Connectors 3-pole



IP 67

Material:

Polyamid 6
Neopren
Perbunan

Temperaturbereich:

-40°C bis 105°C

Bei Verwendung mit Zubehör bitte die jeweiligen Zubehör-Temperaturangaben beachten.

Farbe(n)/Ausführungen:

• schwarz/grau

Eigenschaften:

- Gerader Kegel oder Winkelkegel
- mit Bajonett 10 SL
- für Wellenschlauch NW 10

Zubehör (siehe Kapitel 5.2):

- Kontakte
- Werkzeuge

Anwendungsbereiche:

- NFZ
- Landmaschinen
- Baumaschinen



Gerader Kegel
Straight cone



Winkelkegel
Angle cone

Material:

Polyamid 6
Neoprene
Perbunan

Temperature range:

-40°C to 105°C

When used with accessories please mind the respective accessory temperature data.

Colour(s)/Designs:

• black/grey

Characteristics:

- Straight cone or angle cone
- with bayonet 10 SL
- for corrugated tube NW 0

Accessories (see chapter 5.2):

- Contacts
- Tools

Applications:

- Heavy trucks
- Agricultural machines
- Construction machines

5.2

Pos. Item	Bezeichnung Description	Farbe Colour	Art.-Nr. Art. no.	VE Stck. PU pcs.
Montagepackung gerader Kegel mit Bajonett 10 SL, bestehend aus: Assembly package straight cone with bayonet 10 SL, consisting of:			7800063	100
1	3-poliges Buchsengehäuse 3-pole jack housing	schwarz black	7805039	1
2	Buchsenkontakt Jack contact		7814011	3
3	O-Ring 10 x 2,5 O-ring 10 x 2,5	schwarz black	8112495	1
4	Klemmdichtring Clamp sealing	schwarz black	8117101	1
5	Gerader Kegel PG 11 mit Bajonett 10 SL Straight cone PG 11 with bayonet 10 SL	schwarz black	9800582	1
6	Überwurfmutter Cap nut	grau grey	9800689	1

Pos. Item	Bezeichnung Description	Farbe Colour	Art.-Nr. Art. no.	VE Stck. PU pcs.
Montagepackung Winkelkegel mit Bajonett 10 SL, bestehend aus: Assembly package angle cone with bayonet 10 SL, consisting of:			7800064	100
1	3-poliges Buchsengehäuse 3-pole jack housing	schwarz black	7805039	1
2	Buchsenkontakt Jack contact		7814011	3
3	O-Ring 10 x 2,5 O-ring 10 x 2,5	schwarz black	8112495	1
4	Klemmdichtring NW 10 Clamp sealing NW 10	schwarz black	8117101	1
5	Winkelkegel PG 11 mit Bajonett 10 SL Angle cone PG 11 with bayonet 10 SL	schwarz black	9800581	1
6	Überwurfmutter Cap nut	grau grey	9800689	1

Sondersteckverbinder mit Gewinde M 24 x 1 2-/3-polig

Special Connectors with Thread M 24 x 1 2-/3-pole



Material:
Polyamid 6
Neopren

Temperaturbereich:

-40°C bis 105°C

Bei Verwendung mit Zubehör bitte die jeweiligen Zubehör-Temperaturangaben beachten.

Farbe(n)/Ausführungen:

- schwarz/grau
- Montagepackungen ab 100 Stück auf Anfrage
- *) Bandware auf Anfrage

Eigenschaften:

- für Wellschlauch NW 10
- Gerader Kegel oder Winkelkegel
- mit Gewinde M 24 x 1

Zubehör (siehe Kapitel...):

- Kontakte
- Werkzeuge
- Dichtung
- Einzeladerabdichtung (5.3)
- Klemmdichtring (5.3)
- Überwurfmutter (5.3)

Anwendungsbereiche:

- NFZ
- Landmaschinen
- Baumaschinen



Gerader Kegel
Straight cone



Winkelkegel
Angle cone

Material:
Polyamide 6
Neoprene

Temperature range:

-40°C to 105°C

When used with accessories please mind the respective accessory temperature data.

Colour(s)/Designs:

- black/grey
- Assembly packages from 100 pcs on request
- *) stripmaterial on request

Characteristics:





- for corrugated tube NW 10
- Straight cone or angle cone
- with thread M 24 x 1

Accessories (see chapter...):

- Contacts
- Tools
- Sealings
- Single wire sealings (5.3)
- Clamp sealing (5.3)
- Cap nut (5.3)

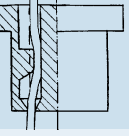
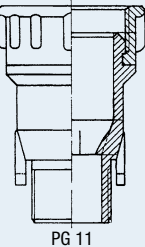
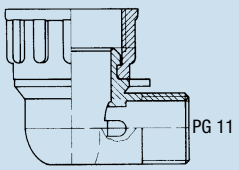
Applications:

- Heavy trucks
- Agricultural machines
- Construction machines

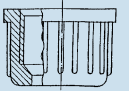
Bezeichnung Description	für for	Farbe Colour	Material Material	Art.-Nr. Art. no.	VE Stck. PU pcs.
 Crimpkontakt Ø 4 mm Crimp contact Ø 4 mm	2-polig 2-pole			7702973 *)	1
	3-polig 3-pole			7702965	1
 Dichtung Sealing	2-polig 2-pole	schwarz black	Neopren Neoprene	7800592	50
	3-polig 3-pole	schwarz black	Neopren Neoprene	7800593	50
 Gerader Kegel PG 11 mit Gewinde M 24 x 1 Straight cone PG 11 with thread M 24 x 1		schwarz black	Polyamid 6 Polyamide 6	9800557	50
 oder/or: Winkelkegel PG 11 mit Gewinde M 24 x 1 Angle cone with thread M 24 x 1		schwarz black	Polyamid 6 Polyamide 6	9800999	50
 Einzeladerabdichtung Single wire sealing		schwarz black	Neopren Neoprene	8113647	50
 Klemmdichtring Clamp sealing		schwarz black	Neopren Neoprene	8117101	50
 Wellschlauch Corrugated tube	NW 10				
 Überwurfmutter Cap nut	NW 10	grau grey	Polyamid Polyamide	9800689	50

Sondersteckverbinder mit Gewinde M 27 x 1 2-/3-/4-polig

Special Connectors with Thread M 27 x 1 2-/3-/4-pole



Material:
Polyamid 6
Neopren
Messing vernickelt

Temperaturbereich:
-40°C bis 105°C
Bei Verwendung mit Zubehör bitte die jeweiligen Zubehör-Temperaturangaben beachten.

Farbe(n)/Ausführungen:
• schwarz/grau
• Montagepackungen ab 100 Stück auf Anfrage
• *) Bandware auf Anfrage

Kennzeichen:
• Gerader Kegel oder Winkelkegel
• mit Gewinde M 27 x 1
• für Wellenschlauch NW 10

Zubehör (siehe Kapitel...):
• Kontakte
• Werkzeuge
• Reduktion
• Dichtung (5.2)
• Einzeladerabdichtung (5.3)
• Klemmdichtring (5.3)
• Überwurfmutter (5.3)

Anwendungsbereiche:
• NFZ
• Landmaschinen
• Baumaschinen



**Gerader Kegel
Straight cone**



**Winkelkegel
Angle cone**







Material:
Polyamid 6
Neopren
brass nickel-plated
Temperature range:
-40°C to 105°C
When used with accessories please mind the respective accessory temperature data.

Colour(s)/Designs:
• black/grey
• Assembly packages from 100 pcs on request
• *) stripmaterial on request

Characteristics:
• Straight cone or angle cone
• with thread M 27 x 1
• for Corrugated tube NW 10

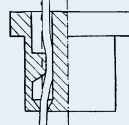
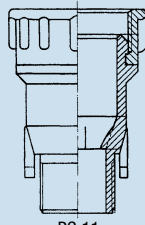
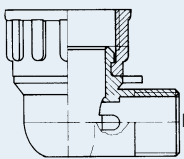
Accessories (see chapter...):
• Contacts
• Tools
• Reduction
• Sealing (5.2)
• Single wire sealing (5.3)
• Clamp sealing (5.3)
• Cap nut (5.3)

Applications:
• Heavy trucks
• Agricultural machines
• Construction machines

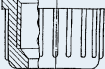
Bezeichnung Description	für for	Farbe Colour	Material Material	Art.-Nr. Art. no.	VE Stck. PU pcs.	
	optional M 27/M 24 optional M 27/M 24		Messing vernickelt brass nickel-plated	6100333	50	
	2-/4-polig 2-/4-pole			7702973 *)	1	
	3-polig 3-pole			7702965	1	
	2-polig 2-pole	schwarz black	Neopren Neoprene	7800665/7800711	50	
	3-polig 3-pole	schwarz black	Neopren Neoprene	7800673	50	
	4-polig 4-pole	schwarz black	Neopren Neoprene	7800681/7800720	50	
 PG 11	Gerader Kegel PG 11 mit Gewinde M 27 x 1 Straight cone PG 11 with thread M 27 x 1	schwarz black	Polyamid 6 Polyamide 6	9800794	50	
 PG 11	oder/or: Winkelkegel PG 11 mit Gewinde M 27 x 1 Angle cone PG 11 with thread M 27 x 1	schwarz black	Polyamid 6 Polyamide 6	9800808	50	
	Einzeladerabdichtung Single wire sealing	schwarz black	Neopren Neoprene	8113647	50	
	Klemmdichtring Clamp sealing	NW 10	schwarz black	Neopren Neoprene	8117101	50
	Wellenschlauch Corrugated tube	NW 10				
	Überwurfmutter Cap nut	NW 10	grau grey	Polyamid Polyamide	9800689	50

Sondersteckverbinder mit Bajonett 2-/3-/4-polig

Special Connectors with Bayonet 2-/3-/4-pole



IP 67

Material:

Polyamid 6
Neopren

Temperaturbereich:

-40°C bis 105°C

Bei Verwendung mit Zubehör bitte die jeweiligen Zubehör-Temperaturangaben beachten.

Farbe(n)/Ausführungen:

- schwarz/grau
- Montagepackungen ab 100 Stück auf Anfrage
- *) Bandware auf Anfrage

Eigenschaften:

- Gerader Kegel oder Winkelkegel
- mit Bajonett 16S
- für Wellschlauch NW 10

Zubehör (siehe Kapitel...):

- Kontakte
- Werkzeuge
- Dichtung (5.2)
- Einzeladerabdichtung (5.3)
- Klemmdichtring (5.3)
- Überwurfmutter (5.3)

Anwendungsbereiche:

- NFZ
- Landmaschinen
- Baumaschinen



Gerader Kegel
Straight cone



Winkelkegel
Angle cone

Material:

Polyamid 6
Neoprene

Temperature range:

-40°C to 105°C

When used with accessories please mind the respective accessory temperature data.

Colour(s)/Designs:

- black/grey
- Assembly packages from 100 pcs on request
- *) stripmaterial on request

Characteristics:

- Straight cone or angle cone
- with bayonet 16S
- for corrugated tube NW 10

Accessories (see chapter...):

- Contacts
- Tools
- Sealing (5.2)
- Single wire sealing (5.3)
- Clamp sealing (5.3)
- Cap nut (5.3)

Applications:

- Heavy trucks
- Agricultural machines
- Construction machines

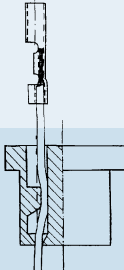
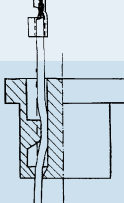
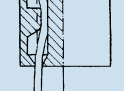
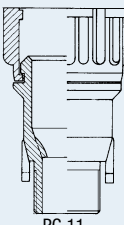
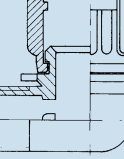
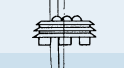
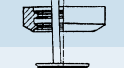
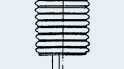
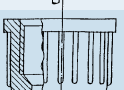
Bezeichnung Description	für for	Farbe Colour	Material Material	Art.-Nr. Art. no.	VE Stck. PU pcs.	
 Crimpkontakt Crimp contact	2-/4-polig 2-/4-pole			7702973 *)	1	
	 Lötkontakt Solder contact	3-polig 3-pole			7702965	1
		2-polig / 2-pole	schwarz black	Neopren Neoprene	7800630/7800704	50
		3-polig / 3-pole	schwarz black	Neopren Neoprene	7800622	50
 Dichtung Sealing	4-polig / 4-pole	schwarz black	Neopren Neoprene	7800615/7800738	50	
	 Gerader Kegel PG 11 mit Bajonett 16 S Straight cone PG 11 with bayonet 16 S		schwarz black	Polyamid 6 Polyamide 6	9800611	50
		 Winkelkegel PG 11 mit Bajonett 16 S Angle cone PG 11 with bayonet 16 S		schwarz black	Polyamid 6 Polyamide 6	9800603
 Einzeladerabdichtung Single wire sealing			schwarz black	Neopren Neoprene	8113647	50
 Klemmdichtring Clamp sealing	NW 10	schwarz black	Neopren Neoprene	8117101	50	
 Wellschlauch Corrugated tube	NW 10					
 Überwurfmutter Cap nut	NW 10	grau grey	Polyamid Polyamide	9800689	50	

Dichtungen für Sondersteckverbinder

Sealings for Special Connectors



Material:
Neopren
Temperaturbereich:
-40°C bis 105°C

Farbe(n)/Ausführungen:
• schwarz
Eigenschaften:
• für Leitungen FLRY und FLY

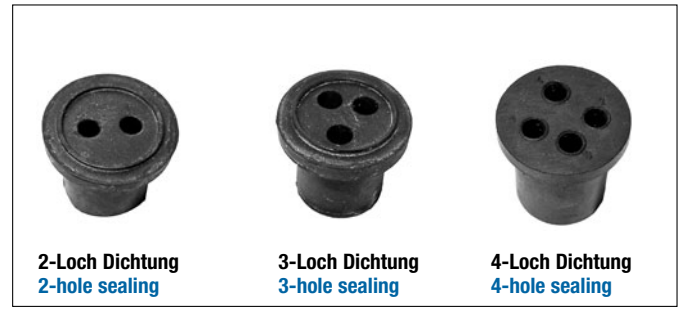

Material:
Neoprene
Temperature range:
-40°C to 105°C
Colour(s)/Designs:
• black
Characteristics:
• for wires FLRY and FLY

Bezeichnung Description	für for	Ausführung Type	Z mm Z mm	Art.-Nr. Art. no.	VE Stck. PU pcs.
2-Loch-Dichtung 2-hole sealing 	Gerader Kegel oder Winkelkegel mit Gewinde M 27 x 1 Straight cone or angle cone with thread M 27 x 1	2 x Einfach-Kabelanschlag 2 x Single-cable crimping	3,5	7800665	50
	Gerader Kegel oder Winkelkegel mit Bajonett 16S Straight cone or angle cone with bayonet 16S		5,5	7800630	50
2-Loch-Dichtung 2-hole sealing 	Gerader Kegel oder Winkelkegel mit Gewinde M 27 x 1 Straight cone or angle cone with thread M 27 x 1	1 x Einfach-Kabelanschlag 1 x Doppel-Kabelanschlag 1 x Single-cable crimping 1 x Double-cable crimping	3,5	7800711	50
	Gerader Kegel oder Winkelkegel mit Bajonett 16S Straight cone or angle cone with bayonet 16S		5,5	7800704	50
3-Loch-Dichtung 3-hole sealing 	Gerader Kegel oder Winkelkegel mit Gewinde M 27 x 1 Straight cone or angle cone with thread M 27 x 1	3 x Einfach-Kabelanschlag 3 x Single-cable crimping	3,5	7800673	50
	Gerader Kegel oder Winkelkegel mit Bajonett 16S Straight cone or angle cone with bayonet 16S		5,5	7800622	50
4-Loch-Dichtung 4-hole sealing 	Gerader Kegel oder Winkelkegel mit Gewinde M 27 x 1 Straight cone or angle cone with thread M 27 x 1	4 x Einfach-Kabelanschlag 4 x Single-cable crimping	3,5	7800681	50
	Gerader Kegel oder Winkelkegel mit Bajonett 16S Straight cone or angle cone with bayonet 16S		5,5	7800614	50
4-Loch-Dichtung 4-hole sealing 	Gerader Kegel oder Winkelkegel mit Gewinde M 27 x 1 Straight cone or angle cone with thread M 27 x 1	1 x Einfach-Kabelanschlag 3 x Doppel-Kabelanschlag 1 x Single-cable crimping 3 x Double-cable crimping	3,5	7800720	50
	Gerader Kegel oder Winkelkegel mit Bajonett 16S Straight cone or angle cone with bayonet 16S		5,5	7800738	50

5.2

ABS/EBS/15-pol. Steckverbinder

ABS/EBS/15-pole Connectors



Material:
Polyamid glasfaserverstärkt
Metallteile: rostfreier Stahl
Kontaktteile: Cu-Legierung,
oberflächenveredelt

Temperaturbereich:
-40°C bis 110°C

Eigenschaften:

- 5-/7-polig: nach ISO 7638/4091
- 15-polig: nach ISO 12098/4091
- Leitungsknickschutz (bei Stecker)

Kontakte:

- Lebensdauer: 10.000 Steckzyklen

Anwendungsbereich:

- NFZ



**Stecker
Plug**



**Steckdose
Socket**

Material:
Polyamide glassfibre reinforced
Metal parts: stainless steel
Contact parts: copper alloy
with surface treatment

Temperature range:
-40°C to 110°C

Characteristics:

- 5-/7-pole acc. to ISO 7638/4091
- 15-pole acc. to ISO 12098/4091
- Cable kink protection (at plug)

Contacts:

- Live cycle: 10,000 cycles

Applications:

- Heavy trucks

Bezeichnung	Art.-Nr.	VE Stck.
Description	Art. no.	PU pcs.
ABS/EBS-Stecker	ABS/EBS plug	
5-polig 24 V, 3x1,5 mm ² , 2x6 mm ²	5-pole 24 V, 3x1,5 mm ² , 2x6 mm ²	7705555
5-polig 24 V, 3x1,5 mm ² , 2x4 mm ²	5-pole 24 V, 3x1,5 mm ² , 2x4 mm ²	7705558
7-polig 24 V, 5x1,5 mm ² , 2x4 mm ²	7-pole 24 V, 5x1,5 mm ² , 2x4 mm ²	7705551
15-polig 24 V, 12x1,5 mm ² , 3x2,5 mm ²	15-pole 24 V, 12x1,5 mm ² , 3x2,5 mm ²	7705202
ABS/EBS-Steckdose	ABS/EBS socket	
5-polig 24 V, 3x1,5 mm ² , 2x6 mm ²	5-pole 24 V, 3x1,5 mm ² , 2x6 mm ²	7705567
5-polig 24 V, 3x1,5 mm ² , 2x4 mm ²	5-pole 24 V, 3x1,5 mm ² , 2x4 mm ²	7705563
7-polig 24 V, 5x1,5 mm ² , 2x4 mm ²	7-pole 24 V, 5x1,5 mm ² , 2x4 mm ²	7705552
15-polig 24 V, 12x1,5 mm ² , 3x2,5 mm ²	15-pole 24 V, 12x1,5 mm ² , 3x2,5 mm ²	7705205

ABS-Parkdose

ABS Parking Socket



Material:

Polyamid glasfaserverstärkt

Temperaturbereich:

-40°C bis 110°C

Eigenschaften:

- Nach ISO 7638/12098/4091
- Metallteile aus rostfreiem Stahl
- Glattflächiger Deckel vermeidet Verletzungen
- Deckelfeder innenliegend, dadurch geschützt vor Beschädigungen

- Parkdose dient zur staub- und wassergeschützten Aufbewahrung des Steckers, wenn der Anhänger nicht mit dem Zugfahrzeug verbunden ist.

Anwendungsbereich:

- NFZ

Material:

Polyamide glassfibre reinforced

Temperature range:

-40°C to 110°C

Characteristics:

- Acc. to ISO 7638/12098/4091
- Metal parts are made of stainless steel
- Smooth cap avoids injuries
- Inner cap spring is protected against damages



- Parking socket for dust and waterproof saving of the plug while the trailer is not connected with the traction vehicle.

Applications:

- Heavy trucks

Bezeichnung	Art.-Nr.	VE Stck.
Description	Art. no.	PU pcs.
ABS-Parkdose / ABS Parking socket	7705569	1

Ersatzkontakte

Replacement Contacts



Material:

auf Anfrage

Temperaturbereich:

-40°C bis 110°C

Eigenschaften:

Montagepackungen auf Anfrage

Material:

on request

Temperature range:

-40°C to 110°C

Characteristics:

Assembly packages on request



Buchsenkontakt
Jack contact

Bezeichnung	Art.-Nr.	VE Stck.	
Description	Art. no.	PU pcs.	
Buchsenkontakt, 1,5 mm ² für 7705555, 7705551	Jack contact 1,5 mm ² for 7705555, 7705551	9530177	1
Buchsenkontakt, 1,5 mm ² für 7705202	Jack contact 1,5 mm ² for 7705202	9530174	1
Buchsenkontakt, 2,5 mm ² für 7705202	Jack contact 2,5 mm ² for 7705202	9530188	1
Buchsenkontakt, 4 mm ² für 7705551	Jack contact 4 mm ² for 7705551	9530184	1
Buchsenkontakt, 6 mm ² für 7705555	Jack contact 6 mm ² for 7705555	9530185	1
Stiftkontakt, 1,5 mm ² für 7705567/7705563/7705552/7705205	Pin contact 1,5 mm ² for 7705567/7705563/7705552/7705205	9530160	1
Stiftkontakt, 2,5 mm ² für 7705205	Pin contact 2,5 mm ² for 7705205	9530163	1
Stiftkontakt, 4 mm ² für 7705563/7705552	Pin contact 4 mm ² for 7705563/7705552	9530161	1
Stiftkontakt, 6 mm ² für 7705567	Pin contact 6 mm ² for 7705567	9530162	1

ABS/EBS/15-pol. Wendelleitungen

ABS/EBS/15-pole Spiral Conduits



Material:

Wendelleitungs-Mantel: Hytrel
Stecker-Gehäuse:
Polyamid glasfaserverstärkt
Metallteile: rostfreier Stahl
Kontaktteile: Cu-Legierung
mit Oberflächenveredelung

Temperaturbereich:

-40°C bis 110°C

Eigenschaften:

- Nach ISO 4091/4141/7638/12098
- Leichte Handhabung durch Verriegelungsbügel
- Mit Leitungs-Knickschutz

Anwendungsbereich:

- NFZ

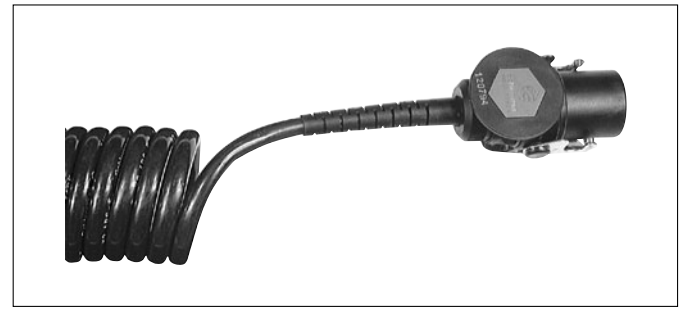

Material:

Spiral cable outer cover: Hytrel
Plug housing: Polyamide glassfibre reinforced
Metal parts: stainless steel
Contact parts: copper alloy with surface treatment

Temperature range:

-40°C to 110°C

Characteristics:

- Acc. to ISO 4091/4141/7638/12098
- Easy mounting because of locking mechanism
- With cable-kink-protection

Applications:

- Heavy trucks

5.2

Bezeichnung	Description	Wendel- Außen-Ø	max. Länge	Windungen ca.	Art.-Nr.	VE Stck.
		Spiral outer Ø	max. length	turns approx.	Art. no.	PU pcs.
ABS-Wendelleitung 3x1,5 mm ² , 2x4 mm ²	ABS spiral conduit 3x1,5 mm ² , 2x4 mm ²	100 mm	3500 mm	17	9500099	1
EBS-Wendelleitung 5x1,5 mm ² , 2x4 mm ²	EBS spiral conduit 5x1,5 mm ² , 2x4 mm ²	100 mm	4000 mm		9500100	1
Wendelleitung 15-adrig 12x1,5 mm ² , 3x2,5 mm ²	spiral conduit 15-pole 12x1,5 mm ² , 3x2,5 mm ²	110 mm	4000 mm	19	9500020	1